

Oxygen probe for inter-gas applications

Overview

| | |
|---|---|
| Pressure range | Gas tight and pressure proof up to 2 bar |
| Temperature range | 500°C – 1300°C |
| Built-in thermocouple | Combined sensor Type S or none |
| Diameter outer protection tube | Ø 17 mm |
| Material outer protection tube | High density Al ₂ O ₃ 99,7% |
| Diameter electrolyte tube | Ø 6 mm |
| Material electrolyte tube | Fully stabilized zirconium dioxide (FSZ) |
| Material gas electrode | Pt pure |
| Material reference electrode | Pt pure |
| Wires used for connection of electrodes | Pt pure |
| Fitting purge air supply | Plug Ø 6 mm |
| Fitting reference air supply | Plug Ø 6 mm |
| Electrical connection | Ceramic terminals max 1,5 mm ² |
| Connection head | Form A with M20x1,5 cable gland max 250°C |
| Certificates | <p><u>Thermocouple:</u> Report of calibration based on Ag and Pd fix-point measurements at type PtRhX – Pt</p> <p><u>Optional:</u> Certification in accordance to AMS 2750</p> <p><u>Oxygen sensor:</u> Report of function test including inner resistance, leak rate of electrolyte tube and mV in N₂ 6.0 and N₂H₂(5%) at 920°C</p> |

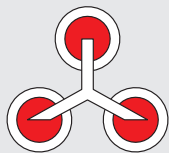



Process connection with thread

Process connection with thread

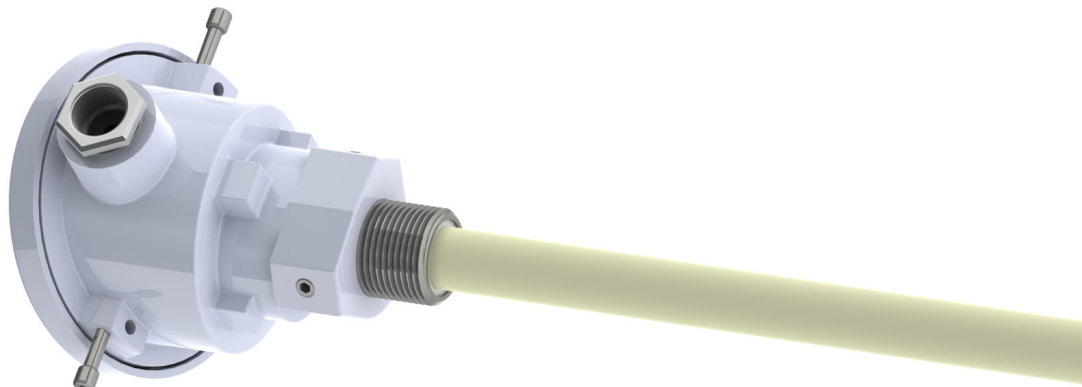

Standard configuration is a G3/4 DIN 228 thread with a length of 20 mm. Other threads such as G1" or NPT are available upon request.

2

Product specification keys:

| 9 | - | 01XXZZ | - | LLLLA |
|---|---|---|---|---|
| | | 01 – Inert-gas design XX – Built-in Thermocouple 00 – none 01 – with ZZ – Thermocouple alloy pairs 00 – none 01 – PtRh10% - Pt (Type S) 02 – PtRh13% - Pt (Type R) | | LLLL – Nominal length [mm] 0400 – 400 mm to 1000 – 1000 mm in 100 mm steps A – Fitting G34 – G3/4" Thread G1 – G1" Thread G1SW28 – G1" Thread with HEX28 neck |

Example: 9-010101-0500G34

Oxygen probe for inert-gas application, as combined sensor with built-in type S thermocouple, a nominal length of 500 mm and a G3/4" thread.

Please let us know if you need a specific design or configuration. We will be happy to design your custom-made oxygen probe.

Process connection with thread

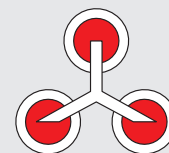

Inert-gas oxygen with G3/4 thread

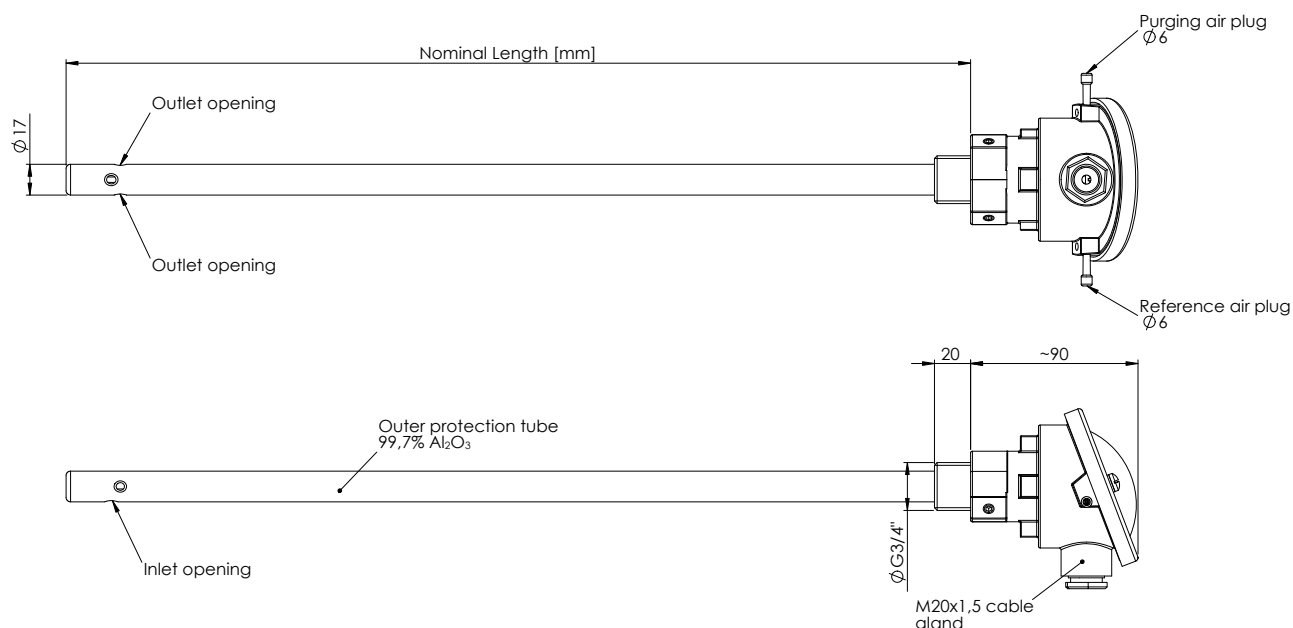

As combined sensor with a built-in thermocouple type S (PtRh10% - Pt)

| Material-No | Description | Specification |
|-------------|---|------------------|
| 520461 | Inert-gas oxygen probe 500 mm, 1 x Type S with G3/4 thread | 9-010101-0500G34 |
| 509913 | Inert-gas oxygen probe 600 mm, 1 x Type S with G3/4 thread | 9-010101-0600G34 |
| 509914 | Inert-gas oxygen probe 700 mm, 1 x Type S with G3/4 thread | 9-010101-0700G34 |
| 509915 | Inert-gas oxygen probe 800 mm, 1 x Type S with G3/4 thread | 9-010101-0800G34 |
| 520631 | Inert-gas oxygen probe 900 mm, 1 x Type S with G3/4 thread | 9-010101-0900G34 |
| 509916 | Inert-gas oxygen probe 1000 mm, 1 x Type S with G3/4 thread | 9-010101-1000G34 |

Without thermocouple

| Material-No | Description | Specification |
|-------------|---|------------------|
| 92000184 | Inert-gas oxygen probe 500 mm with G3/4 thread | 9-010000-0500G34 |
| 92000946 | Inert-gas oxygen probe 600 mm with G3/4 thread | 9-010000-0600G34 |
| 92000947 | Inert-gas oxygen probe 700 mm with G3/4 thread | 9-010000-0700G34 |
| 92000948 | Inert-gas oxygen probe 800 mm with G3/4 thread | 9-010000-0800G34 |
| 92000949 | Inert-gas oxygen probe 900 mm with G3/4 thread | 9-010000-0900G34 |
| 92000950 | Inert-gas oxygen probe 1000 mm with G3/4 thread | 9-010000-1000G34 |

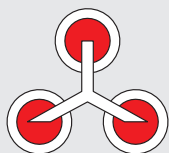

Process connection with thread

Inert-gas oxygen probe with G1 inch thread

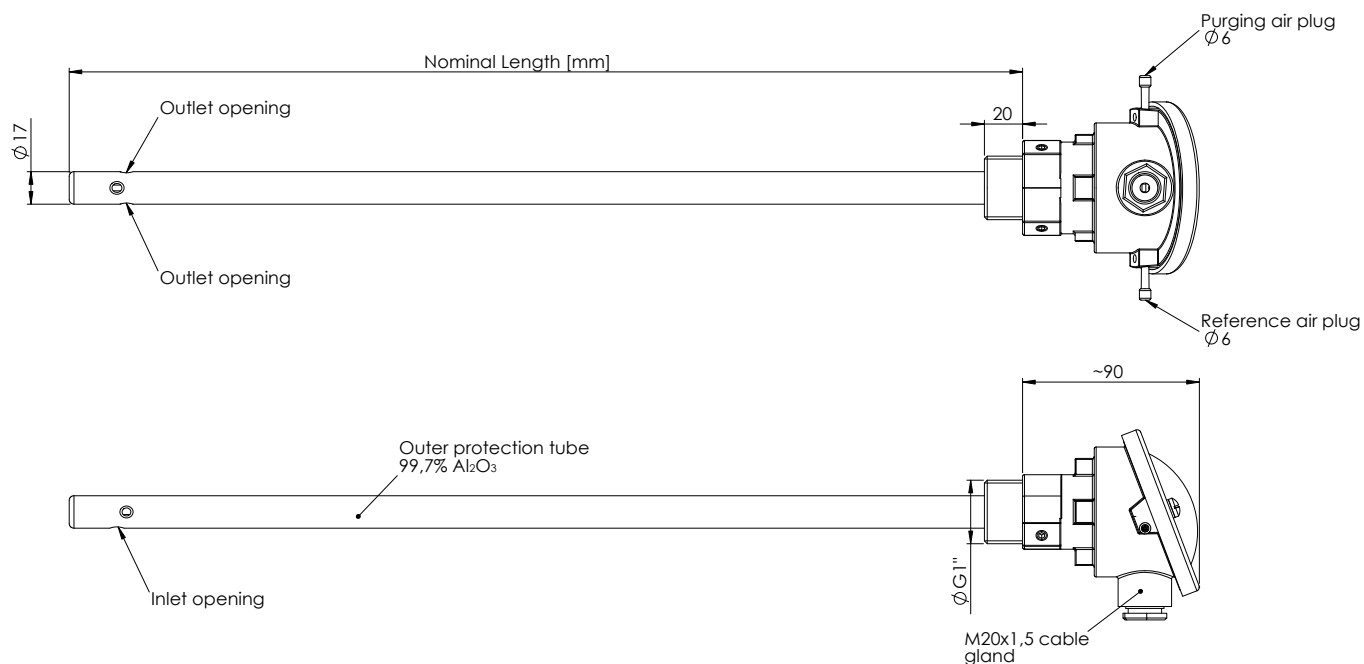

As combined sensor with a built-in thermocouple type S(PtRh10% - Pt)

| Material-No | Description | Specification |
|-------------|---|-----------------|
| 520861 | Inert-gas oxygen probe 500 mm, 1 x Type S with G1 thread | 9-010101-0500G1 |
| 92000955 | Inert-gas oxygen probe 600 mm, 1 x Type S with G1 thread | 9-010101-0600G1 |
| 92000956 | Inert-gas oxygen probe 700 mm, 1 x Type S with G1 thread | 9-010101-0700G1 |
| 92000957 | Inert-gas oxygen probe 800 mm, 1 x Type S with G1 thread | 9-010101-0800G1 |
| 92000958 | Inert-gas oxygen probe 900 mm, 1 x Type S with G1 thread | 9-010101-0900G1 |
| 92000959 | Inert-gas oxygen probe 1000 mm, 1 x Type S with G1 thread | 9-010101-1000G1 |

Without thermocouple

| Material-No | Description | Specification |
|-------------|---|-----------------|
| 521030 | Inert-gas oxygen probe 500 mm, with G1 thread | 9-010000-0500G1 |
| 521031 | Inert-gas oxygen probe 600 mm with G1 thread | 9-010000-0600G1 |
| 512581 | Inert-gas oxygen probe 700 mm with G1 thread | 9-010000-0700G1 |
| 92000952 | Inert-gas oxygen probe 800 mm with G1 thread | 9-010000-0800G1 |
| 92000953 | Inert-gas oxygen probe 900 mm with G1 thread | 9-010000-0900G1 |
| 92000954 | Inert-gas oxygen probe 1000 mm with G1 thread | 9-010000-1000G1 |

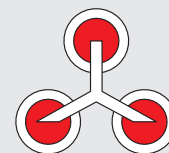

Process connection with thread

Inert-gas oxygen probe with G1 inch Thread and HEX28 neck

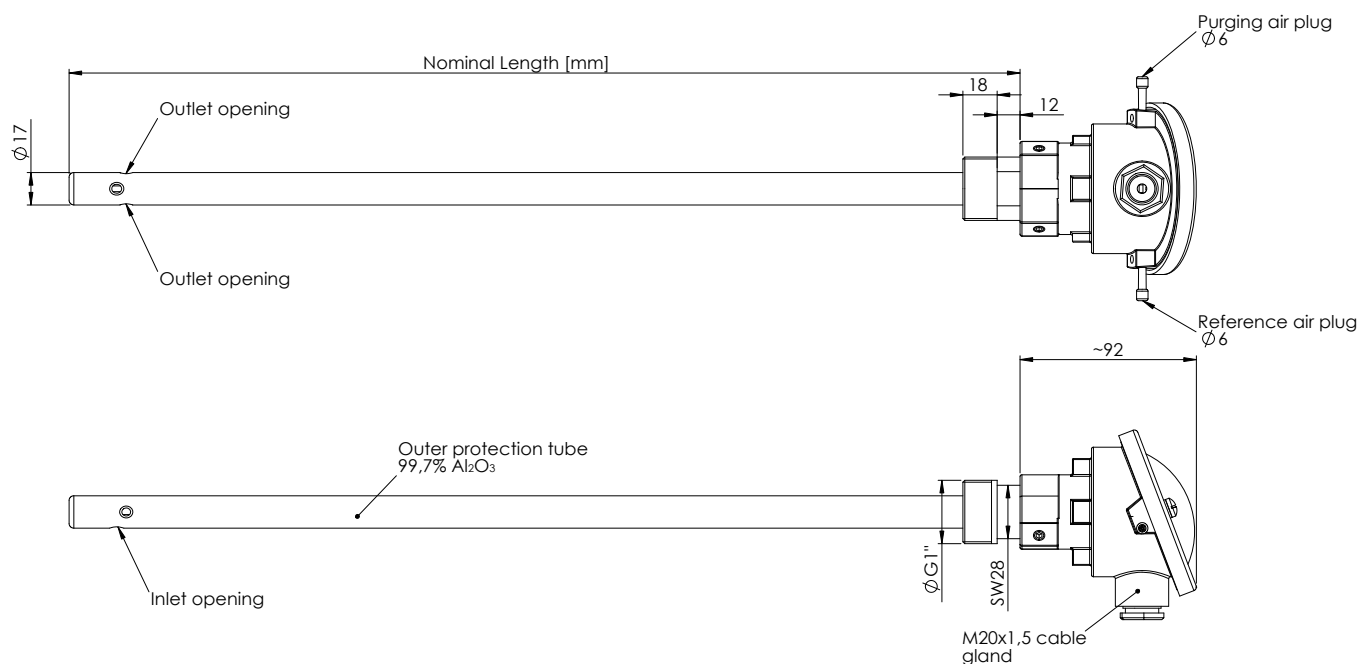

As combined sensor with a built-in thermocouple type S (PtRh10% - Pt)

| Material-No | Description | Specification |
|-------------|--|---------------------|
| 92000960 | Inert-gas oxygen probe 500 mm, 1 x Type S with G1 thread and HEX28 neck | 9-010101-0500G1SW28 |
| 92000138 | Inert-gas oxygen probe 600 mm, 1 x Type S with G1 thread and HEX28 neck | 9-010101-0600G1SW28 |
| 92000961 | Inert-gas oxygen probe 700 mm, 1 x Type S with G1 thread and HEX28 neck | 9-010101-0700G1SW28 |
| 92000962 | Inert-gas oxygen probe 800 mm, 1 x Type S with G1 thread and HEX28 neck | 9-010101-0800G1SW28 |
| 92000973 | Inert-gas oxygen probe 900 mm, 1 x Type S with G1 thread and HEX28 neck | 9-010101-0900G1SW28 |
| 92000974 | Inert-gas oxygen probe 1000 mm, 1 x Type S with G1 thread and HEX28 neck | 9-010101-1000G1SW28 |

Without thermocouple

| Material-No | Description | Specification |
|-------------|--|---------------------|
| 92000975 | Inert-gas oxygen probe 500 mm with G1 thread and HEX28 neck | 9-010000-0500G1SW28 |
| 92000976 | Inert-gas oxygen probe 600 mm with G1 thread and HEX28 neck | 9-010000-0600G1SW28 |
| 512581 | Inert-gas oxygen probe 700 mm with G1 thread and HEX28 neck | 9-010000-0700G1SW28 |
| 512581 | Inert-gas oxygen probe 800 mm with G1 thread and HEX28 neck | 9-010000-0800G1SW28 |
| 512581 | Inert-gas oxygen probe 900 mm with G1 thread and HEX28 neck | 9-010000-0900G1SW28 |
| 92000086 | Inert-gas oxygen probe 1000 mm with G1 thread and HEX28 neck | 9-010000-1000G1SW28 |



Process connection with tubes

Process connection with tubes

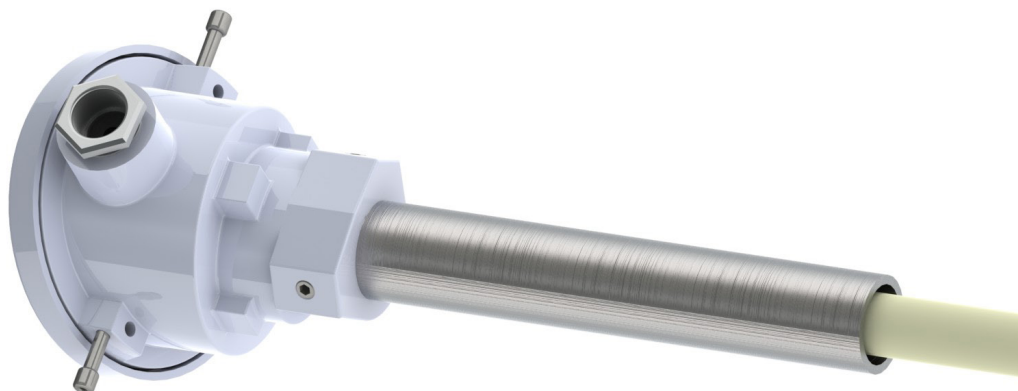

6

The standard design is a stainless-steel tube (W1.4305) Ø22 mm x 150 mm length. Other designs with different tube dimensions such as Ø 1" inch x 150 mm or Ø27 mm x 150 mm are also available.

Product specification keys:

| 9 | - | 01XXZZ | - | LLLLA |
|---|---|---|---|--|
| | | 01 – Inert-gas design XX – Built-in thermocouple 00 – none 01 – with ZZ – Thermocouple alloy pairs 00 - none 01 – PtRh10% - Pt (Type S) 02 – PtRh13% - Pt (Type R) | | LLLL – Nominal length [mm] 0400 – 400 mm to 1000 – 1000 mm in 100 mm steps A – Fitting SR22 – Ø22 mm x 150 mm SG1Z – Ø 1" inch x 150 mm SR27 – Ø27 mm x 150 mm |

Example: 9-010101-0700SR22

Oxygen probe for inert-gas application, as combined sensor with built-in type S thermocouple, a nominal length of 700 mm and a Ø22 mm x 150 mm tube.

Please let us know if you need a specific design or configuration. We will be happy to design your custom-made oxygen probe.

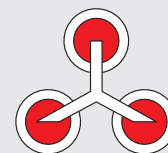

Process connection with tubes

Inert-gas oxygen probe with Ø22 x 150 stainless steel tube

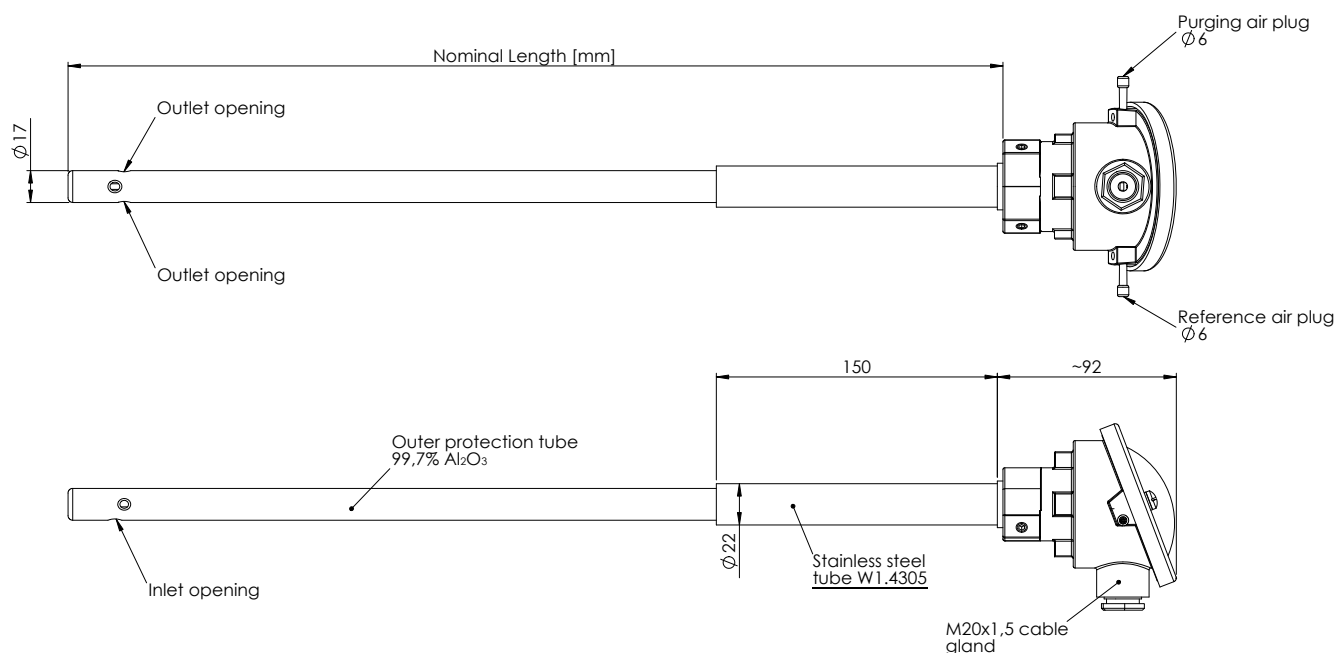

As combined sensor with a built-in thermocouple type S (PtRh10% - Pt)

| Material-No | Description | Specification |
|-------------|---|-------------------|
| 92000819 | Inert-gas oxygen probe 500 mm, 1 x Type S with 22 x 150 stainless steel tube | 9-010101-0500SR22 |
| 520990 | Inert-gas oxygen probe 600 mm, 1 x Type S with 22 x 150 stainless steel tube | 9-010101-0600SR22 |
| 92000994 | Inert-gas oxygen probe 700 mm, 1 x Type S with 22 x 150 stainless steel tube | 9-010101-0700SR22 |
| 92000995 | Inert-gas oxygen probe 800 mm, 1 x Type S with 22 x 150 stainless steel tube | 9-010101-0800SR22 |
| 92000996 | Inert-gas oxygen probe 900 mm, 1 x Type S with 22 x 150 stainless steel tube | 9-010101-0900SR22 |
| 92000997 | Inert-gas oxygen probe 1000 mm, 1 x Type S with 22 x 150 stainless steel tube | 9-010101-1000SR22 |

Oxygen probe without thermocouple

| Material-No | Description | Specification |
|-------------|---|-------------------|
| 92000998 | Inert-gas oxygen probe 500 mm with 22 x 150 stainless steel tube | 9-010000-0500SR22 |
| 92000999 | Inert-gas oxygen probe 600 mm with 22 x 150 stainless steel tube | 9-010000-0600SR22 |
| 92001000 | Inert-gas oxygen probe 700 mm with 22 x 150 stainless steel tube | 9-010000-0700SR22 |
| 92001001 | Inert-gas oxygen probe 800 mm with 22 x 150 stainless steel tube | 9-010000-0800SR22 |
| 92001002 | Inert-gas oxygen probe 900 mm with 22 x 150 stainless steel tube | 9-010000-0900SR22 |
| 92001003 | Inert-gas oxygen probe 1000 mm with 22 x 150 stainless steel tube | 9-010000-1000SR22 |

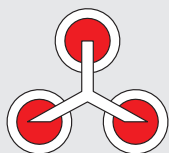

Process connection with tubes

Inert-gas oxygen probe with $\varnothing 27 \times 150$ stainless steel tube

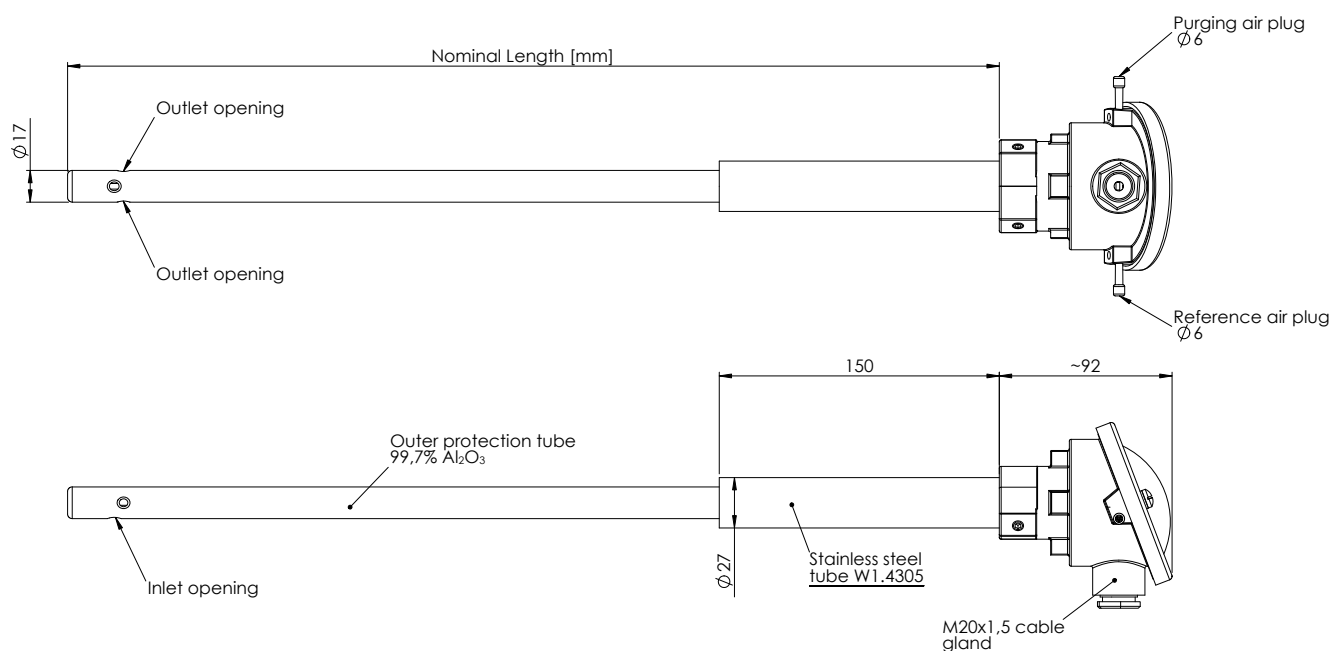

As combined sensor with a built-in thermocouple type S(PtRh10% - Pt)

| Material-No | Description | Specification |
|-------------|---|-------------------|
| 92000157 | Inert-gas oxygen probe 500 mm, 1 x Type S with 27 x 150 stainless steel tube | 9-010101-0500SR27 |
| 92001004 | Inert-gas oxygen probe 600 mm, 1 x Type S with 27 x 150 stainless steel tube | 9-010101-0600SR27 |
| 92001005 | Inert-gas oxygen probe 700 mm, 1 x Type S with 27 x 150 stainless steel tube | 9-010101-0700SR27 |
| 92001006 | Inert-gas oxygen probe 800 mm, 1 x Type S with 27 x 150 stainless steel tube | 9-010101-0800SR27 |
| 92001007 | Inert-gas oxygen probe 900 mm, 1 x Type S with 27 x 150 stainless steel tube | 9-010101-0900SR27 |
| 92001008 | Inert-gas oxygen probe 1000 mm, 1 x Type S with 27 x 150 stainless steel tube | 9-010101-1000SR27 |

Oxygen probe without thermocouple

| Material-No | Description | Specification |
|-------------|---|-------------------|
| 92001009 | Inert-gas oxygen probe 500 mm with 27 x 150 stainless steel tube | 9-010000-0500SR27 |
| 92001010 | Inert-gas oxygen probe 600 mm with 27 x 150 stainless steel tube | 9-010000-0600SR27 |
| 92001011 | Inert-gas oxygen probe 700 mm with 27 x 150 stainless steel tube | 9-010000-0700SR27 |
| 92001012 | Inert-gas oxygen probe 800 mm with 27 x 150 stainless steel tube | 9-010000-0800SR27 |
| 92001013 | Inert-gas oxygen probe 900 mm with 27 x 150 stainless steel tube | 9-010000-0900SR27 |
| 92001014 | Inert-gas oxygen probe 1000 mm with 27 x 150 stainless steel tube | 9-010000-1000SR27 |